



BLACKBERRY RADAR H2M IS

ITH100 – 1

February 2025

ISO Tank Containers

Installation Guide

Table of contents

1	Overview	3
2	Safety and Product Information	4
3	Get ready for installation	11
4	Installing BlackBerry Radar H2M IS modules	12
4.1	Prepare to install.....	12
4.2	Installation tools	14
4.3	Matching a module identifier to an asset identifier	15
4.4	Module installation.....	18
4.4.1	ISO tank container installation procedure	19
4.4.2	Resetting BlackBerry Radar H2M IS modules	28
5	Cleaning BlackBerry Radar H2M IS modules	29
6	Removing BlackBerry Radar H2M IS modules	30
6.1	Removal tools	30
6.2	Module removal	31
6.3	Battery removal and replacement.....	32
6.4	Shipment prep	36
7	Support	42
	Legal notice	43

Revision history

Date	Document number	Rev.	Change description	Author	Approved by
February 28, 2025	DOC-63880-005	1.1	Initial release	Cortez Corley	Scott Dill

1 Overview

This guide provides detailed instructions for installing and activating new BlackBerry Radar H2M IS modules. It includes three main tasks:

Task 1: Get ready for installation (see Section 2)

Task 2: Install a BlackBerry Radar H2M IS module (see Section 3)

- Match the module identifier with the asset identifier on the installation worksheet.
- Install the module onto the asset.

Task 3: Uninstall a module (see Section 6)

- Remove the module from the asset.
- Prepare the device for shipping.

Complete BlackBerry Radar documentation is available online when you log in to BlackBerry Radar Dashboard. For instructions on how to configure the BlackBerry Radar Dashboard or how to activate newly installed devices, see the online documentation.











2 Safety and Product Information

Before you start using the BlackBerry Radar H2M IS™ device (herein after referred to as device), review the safety and regulatory information provided in this document. Keep this document in a safe place so that you can refer to it whenever you need it.

In some countries there may be restrictions on using wireless devices with encryption software. Check with your local authorities for the restrictions in your area.

To find the latest safety and product information, visit:
docs.radar.blackberry.com/guides/user_guide_safety

Important safety precautions

	Do not use the device or magnet near medical devices, including pacemakers and hearing aids, because they might malfunction and cause serious harm or death to you or others.
	Do not dispose of the device, in a fire because this might cause an explosion resulting in serious injury, death, or property loss.
	Do not attempt to install the device or open the device when an explosive atmosphere is present.
	The device is designed to be operated in temperatures between -40 and 85°C (-40 and 185°F). Store device in temperatures between 10 and 30°C (14 and 86°F) and 0-50% humidity. Do not expose the device to temperatures above 100°C (212°F). Use of the device outside of the recommended temperature range could cause damage to the device or lithium-metal battery.
	Do not submerge the device in water.
	Do not puncture, crush, or expose battery to severe physical shock. Do not attempt to disassemble battery pack. Do not short-circuit the battery or allow metallic or conductive objects to contact the battery terminals.
 	Under certain extreme circumstances, the non-metallic parts incorporated in the enclosure of this equipment may generate an ignition-capable level of electrostatic charge. Therefore, the equipment shall not be installed in a location where the external conditions are conducive to the build-up of electrostatic charge on such surfaces. In addition, the equipment shall only be cleaned with a damp cloth.
	Exposure to some chemicals may degrade the sealing properties of materials used in the device. Avoid exposing your device to these chemicals.
	This equipment is not suitable for use in locations where children are likely to be present.
	Keep device magnets away from small children. Potential choking hazard.

Product information: BlackBerry Radar H2M IS ITH100-1

Intrinsic safety warnings

Warning markings
WARNING—DO NOT OPEN WHEN AN EXPLOSIVE ATMOSPHERE IS PRESENT
WARNING—POTENTIAL ELECTROSTATIC CHARGING HAZARD—SEE INSTRUCTIONS
WARNING – DO NOT REMOVE OR REPLACE WHILE CIRCUIT IS LIVE UNLESS THE AREA IS KNOWN TO BE FREE OF IGNITABLE CONCENTRATIONS OF FLAMMABLE GASES OR VAPORS

Mechanical properties:

Weight: Approximately 1045 g (36.9 oz.)

Size: (L x W x H): 314 x 97 x 43.5 mm (12.4 x 3.8 x 1.7 in.)

Electrical Rating / Battery specifications:

Battery operated device

Non-rechargeable lithium-metal battery

7.2V, 38Ah nominal

Environmental properties:

Enclosure Type: IP67/IP69K

Operating Temperature Range: -40 to 85°C (-40 to 185°F)

IECEX/ATEX/cETLus Temperature Range: -40 to 70°C (-40 to 158°F)

Hazardous locations

Hazardous location markings		
IECEX	ATEX	cETLus
Ex ia IIC T4 Ga	CE 2903	Class I, Division 1, Groups A, B, C, D ; T4
Ex ia IIIC T135°C Da	Ex II 1GD	Class I, Division 2, Groups A, B, C, D ; T4
	Ex ia IIC T4 Ga	Class II, Division 1, Groups E, F, G ; T4
	Ex ia IIIC T135°C Da	Class I, Zone 0, AEx ia IIC T4 Ga
		Zone 20, AEx ia IIIC T135°C Da
		Ex ia IIC T4 Ga
		Ex ia IIIC T135°C Da

Relevant standards

Standards	
IECEX	Subject
IEC 60079-0:2017 Ed. 7	Part 0: Equipment – General requirements
IEC 60079-11:2011 Ed. 6	Part 11: Equipment protection by intrinsic safety "i"
ATEX	
EN IEC 60079-0:2018	Part 0: Equipment – General requirements
EN 60079-11:2012	Part 11: Equipment protection by intrinsic safety "i"
cETLus	
CSA C22.2 No. 60079-0:2019 UL 60079-0:2019	Part 0: Equipment – General requirements
CSA C22.2 No. 60079-11:2014 CSA C22.2 No. 60079-11:2013	Part 11: Equipment protection by intrinsic safety "i"
UL 913- 8 th Edition ANSI/ISA–12.12.01–2000	Intrinsically Safe Apparatus and Associated Apparatus for Use in Class I, II, and III, Division 1, Hazardous (Classified) Locations

Radio specifications:

Radio specification	MAX radio conducted power information (EIRP):
LTE B1: 1920~1980 MHz	LTE B1: 26.90 dBm
LTE B2: 1850~1910 MHz	LTE B2: 26.63 dBm
LTE B3: 1710~1785 MHz	LTE B3: 27.20 dBm
LTE B4: 1710~1755 MHz	LTE B4: 26.06 dBm
LTE B5: 824~849 MHz	LTE B5: 25.39 dBm
LTE B8: 880~915 MHz	LTE B8: 24.80 dBm
LTE B12: 698~716 MHz	LTE B12: 22.72 dBm
LTE B13: 777~787 MHz	LTE B13: 23.97 dBm
LTE B20: 832~862 MHz	LTE B20: 24.92 dBm
LTE B25: 1850~1915 MHz	LTE B25: 26.29 dBm
LTE B26: 814~849 MHz	LTE B26: 22.84 dBm
LTE B28: 703~748 MHz	LTE B28: 23.93 dBm
LTE B66: 1710~1780 MHz	LTE B66: 27.40 dBm
LTE B85: 698~716 MHz	LTE B85: 23.97 dBm
869.85 MHz	869.85 MHz: 9.04 dBm
915 MHz: 902~928 MHz	915 MHz: 18.97 dBm
2.4 GHz: 2405~2480 MHz	2.4 GHz: 16.55 dBm

Bands for FCC/ISED include: B2/B4/B5/B12/B13/B25/B26/B66/B85.
 869.85 MHz will be used for CE frequency band and 915 MHz will be used for FCC and ISED frequency band.

Operating temperature and humidity

The BlackBerry Radar H2M IS device is designed for the following temperature and humidity ranges:

Operation:	Storage:
Temperature: (-40 to 85°C) -40 to 185°F	Temperature: -10 to 30°C (14 to 86°F)
Humidity: 0-100%	Humidity: 0-50%

Battery safety

The device contains a non-rechargeable, Lithium Metal battery. Do not attempt to recharge the battery.

The battery might present a fire, explosion, chemical burn, or other hazard if mistreated. Do not put the battery in contact with liquids. Do not heat the battery above 100°C (212°F). Heating the battery above 100°C (212°F) could cause the battery to catch fire or explode.

Antennas



Use only the supplied integrated antennas. Unauthorized antenna modifications or attachments could damage the device and might violate U.S. Federal Communications Commission (FCC) or other regulations.

Repair and maintenance

Do not attempt to modify, disassemble, or service the device. Do not attempt to recharge the battery. Only qualified service personnel should perform repairs, or battery replacements, to the device.

Failure to observe all safety instructions contained in the user documentation for the device will void the Limited Warranty and might lead to suspension or denial of services to the offender, legal action, or both.

Device, magnet, and battery disposal

	Do not dispose of the device, magnet, or battery, in household waste bins or in a fire. Please dispose of magnets in accordance with the laws and regulations in your area. All permanent magnets should be thermally demagnetized prior to disposal or placed in a steel container prior to disposal so the magnets do not attract waste disposal equipment or refuse container.
	The device and battery are recyclable where facilities exist. This symbol is not intended to indicate the use of recycled materials. The Lithium Metal Batteries used in BlackBerry Radar can pose risk of fire, explosion and severe burn hazard if mishandled or damaged. These batteries should never be

placed in regular waste and must be recycled through appropriate e-waste or battery recycling channels. Ensure you dispose of your BlackBerry Radar device and its battery in accordance with the laws and regulations in your area. If you have an **existing waste management partner**, please consult with them regarding disposal, or visit BlackBerry.com/RadarSupport for more information.

Only use BlackBerry battery BAT-63705-003 or BAT-63705-004 in the BlackBerry Radar H2M IS Device. Refer to the [BlackBerry Radar Battery Information Sheet](#) for details on dimensions, weight, and Lithium content per battery. Safety Data Sheets can be provided upon request.

Compliance information

Exposure to radio frequency signals

The device radio is a low-power radio transmitter and receiver. It is designed to comply with Federal Communications Commission (FCC) and Innovation, Science and Economic Development Canada (ISED), and The Council of the European Union guidelines and limits, as well as other relevant international guidelines regarding safety levels of radio frequency exposure for wireless devices. These guidelines were developed by independent scientific experts, governments, and organizations including the Institute of Electrical and Electronics Engineers Standard (IEEE), National Council on Radiation Protection and Measurements (NCRP), and International Commission on Non-Ionizing Radiation Protection (ICNIRP).

FCC compliance statement (United States)

This device complies with Part 15 of the Federal Communications Commission (FCC) Rules under FCC ID: L6AITH100-1. Operation is subject to the following two conditions:

- (1) this device may not cause harmful interference, and
- (2) this device must accept any interference received, including interference that may cause undesired operation.

CAUTION:

Changes or modifications to this unit not expressly approved by the party responsible for compliance could void the user's authority to operate this equipment.

This transmitter must not be co-located or operating in conjunction with any other antenna or transmitter.

NOTE:

This equipment has been tested and found to comply with the limits for a Class B digital device, pursuant to part 15 of the FCC Rules. These limits are designed to provide reasonable protection against harmful interference in a residential installation. This equipment generates uses and can radiate radio frequency energy and, if not installed and used in accordance with the instructions, may cause harmful interference to radio communications. However, there is no guarantee that interference will not occur in a particular installation. If this equipment does cause harmful interference to radio or

television reception, which can be determined by turning the equipment off and on, the user is encouraged to try to correct the interference by one or more of the following measures:

- Reorient or relocate the receiving antenna.
- Increase the separation between the equipment and receiver.
- Connect the equipment into an outlet on a circuit different from that to which the receiver is connected.
- Consult the dealer or an experienced radio/TV technician for help.

Innovation, Science and Economic Development Canada certification

This device complies with Innovation, Science and Economic Development Canada (ISED) license-exempt RSS standard(s). Operation is subject to the following conditions:

- (1) this device may not cause interference, and
- (2) this device must accept any interference, including interference that may cause undesired operation of the device.

This device complies with ISED RSS 130, RSS 132, RSS 133, RSS 139 and RSS-GEN under Certification Number 2503A-ITH1001.

Le présent appareil est conforme aux Innovation, Sciences et Développement économique Canada (ISED) applicables aux appareils radio exempts de licence. L'exploitation est autorisée aux deux conditions suivantes:

- (1) l'appareil ne doit pas produire de brouillage, et
- (2) l'utilisateur de l'appareil doit accepter tout brouillage radioélectrique subi, même si le brouillage est susceptible d'en compromettre le fonctionnement.

L'appareil est conforme aux normes ISED RSS 130, RSS 132, RSS 133, RSS 139 et RSS-GEN sous le numéro d'agrément 2503A-ITH1001.

Radiation exposure statement:

This equipment complies with FCC + ISED radiation exposure limits set forth for an uncontrolled environment. This equipment should be installed and operated with greater than 23 cm between the radiator and your body.

Déclaration d'exposition aux radiations:

Cet équipement est conforme aux limites d'exposition aux rayonnements FCC + ISED établies pour un environnement non contrôlé. Cet équipement doit être installé et utilisé à plus de 23 cm entre le radiateur et votre corps.

Class B compliance

This device complies with the Class B limits for radio noise emissions as set out in the interference-causing equipment standard entitled "Information Technology Equipment

(ITE)--Limits and methods of measurement,” ICES-003 of Innovation, Science and Economic Development Canada.

EU + UKCA regulatory conformance

Hereby, BlackBerry declares that the radio equipment, BlackBerry Radar H2M IS ITH100-1 is in compliance with: Directive 2014/53/EU and UK Radio Equipment Regulations 2017 SI 2017/1206.

The full text of the EU + UKCA declarations of conformity is available at the following internet address: docs.radar.blackberry.com/guides/user_guide_conformity

Additional regulatory conformance

Specific details about compliance to the standards and regulatory bodies for the device may be obtained from BlackBerry.

3 Get ready for installation

To complete the installation of your module, you will require a smartphone with internet access to download the BlackBerry Radar Mobile App. This app will allow you to record the pairing of each BlackBerry Radar H2M IS module to its asset (that is, the object that the device will be installed on) and its associated BlackBerry Radar modules.



For detailed instructions on the BlackBerry Radar Mobile App, log in to the BlackBerry Radar Dashboard and access “Documentation” from the main menu.

If you are unable to utilize the BlackBerry Radar Mobile App during your installation, you need to obtain a worksheet where you can record the pairing of each BlackBerry Radar H2M IS module to its asset and associated BlackBerry Radar accessory devices.

For your convenience, you may quickly create a record of the module and asset identifier pairings by removing the partially attached label from the inner housing of the module and placing it on the installation worksheet, next to the asset that will be tracked by the module.



4 Installing BlackBerry Radar H2M IS modules

You may have a large number of BlackBerry Radar H2M IS modules to install. Follow the instructions in this section to:

- Match each module identifier to its asset identifier
- Install the module to the asset you wish to track.

4.1 Prepare to install

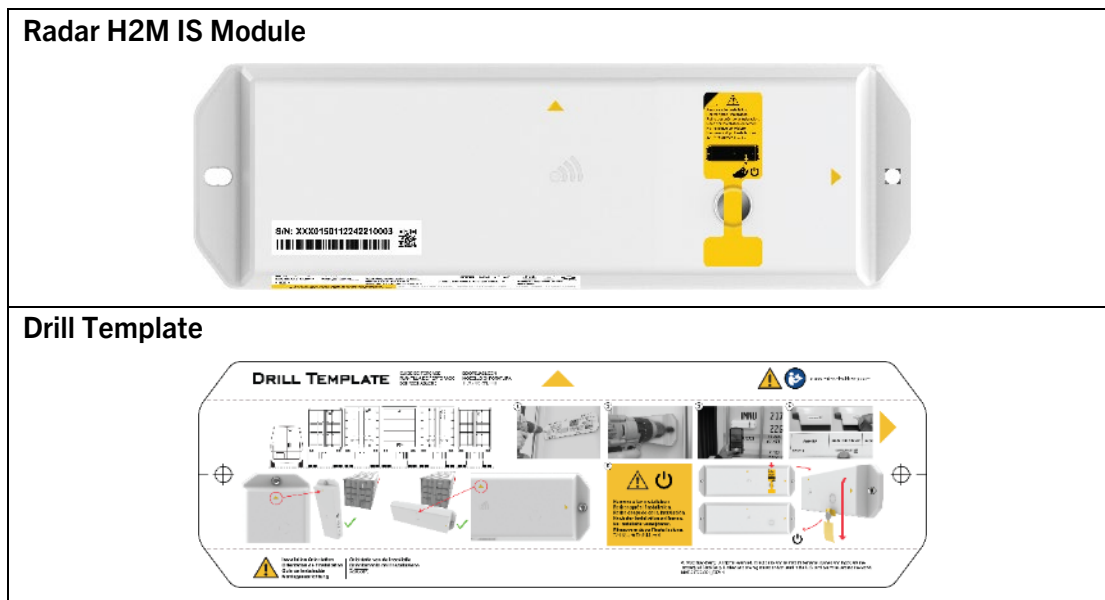

To complete the installation of the module to your assets, you will need the following components. The following components are contained in the module packaging.

Radar H2M IS Module Package Contents



If you are missing any of the above components in your package, contact your BlackBerry Sales Representative.

To attach the module to the asset you wish to track, you must supply your own fasteners. Depending on the construction of your mounting location, you may wish to use the following types of fasteners. **NOTE:** Your choice of fastener will influence the size of the tools required to create the mounting holes (i.e. drill bits) and install or remove the fasteners (i.e. wrenches/sockets/drivers). Also, the actual length of the fasteners will be determined by the thickness of your mounting surface. An example of these points is provided, below.

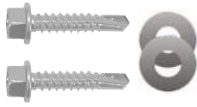
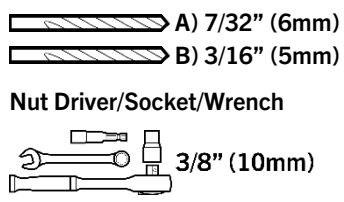
<p>IMPORTANT: The maximum fastener thread diameter supported by this product is 1/4" or M6 (6 mm). For most secure fastening, we do not recommend using fasteners with a thread diameter less than 1/4" or M6.</p>		
<p>Box Section (+3mm wall thickness)</p> 	<p>A) 2 Thread Rolling Screws (3/8" head, 1/4"-20 thread, 3/4" length)</p>  <p>B) 2 Self-Tapping Screws and Washers (3/8" head, 1/4"-14 thread, 1-1/4" length)</p>  <p><i>*For installation in narrow clearance areas, blunt-ended screws--like thread rolling screws--are recommended.</i></p>	<p>Drill Bit</p> <p>A) 7/32" (6mm)</p> <p>B) 3/16" (5mm)</p> <p>Nut Driver/Socket/Wrench</p> <p>3/8" (10mm)</p> 

Fastener selection considerations—Thread rolling screws



You may also wish to install your BlackBerry Radar H2M IS on your asset where you may not have access to the rear of your fastener, to install a nut. In these scenarios, we recommend using thread rolling screws.



Thread rolling screws create their own threads within the thickness of the asset's installation surface. These threads allow the module to be secured to the asset, without the use of a secondary fastener, like a lock nut (although some thread rolling screws can be used with some lock nuts, for extra holding opportunity).

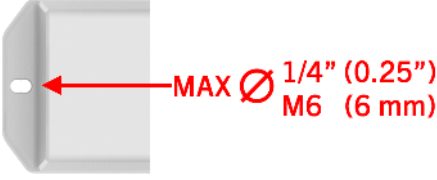

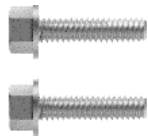

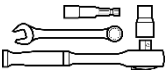
As you will need to supply the fasteners, the length of the thread-rolling screw will be determined by the depth of the installation surface and the depth of the Radar H2M IS Mounting flange. The drill bit diameter will also be determined by the thread diameter of the selected fastener. **REMEMBER:** the diameter of the hole drilled into the installation surfaces must be 10-20% smaller than the fastener's thread diameter. Below is an example.

<p>IMPORTANT: The maximum fastener thread diameter supported by this product is 1/4" (0.25") or M6 (6 mm). For most secure fastening, we do not recommend using fasteners with a thread diameter less than 1/4" or M6.</p>	
---	--



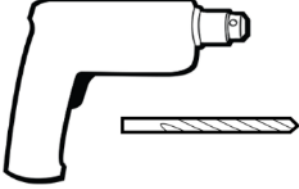

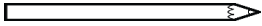
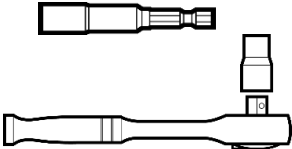

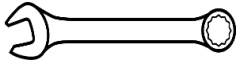
<p>Box Section (+3mm wall thickness)</p> 	<p>2 Thread Rolling Screws (3/8" head, 1/4"-20 thread, 1-1/4" length) (10 mm head, M6 thread, 31mm length)</p> 	<p>Drill Bit</p>  <p>7/32" (6 mm)</p> <p>Nut Driver/Socket/Wrench</p>  <p>3/8" (10mm)</p>
---	---	---

4.2 Installation tools

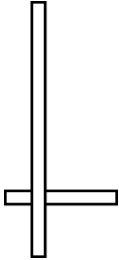
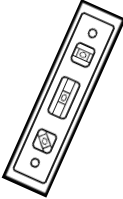
Required tools to complete the installation:

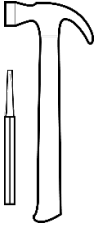
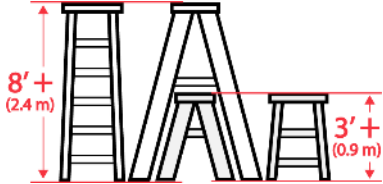
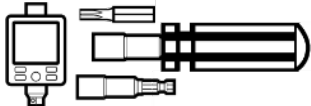
<p>Smartphone with BlackBerry Radar Mobile App + Internet Access*</p>  <p>* IOS or Android equipped smartphone required. Internet connectivity is required during the entire installation process.</p>	<p>Drill and Drill Bits</p> 	<p>Tape</p>  <p>Pencil or Non-Permanent Marker</p> 
<p>Nut Driver or Socket Wrench with Socket*</p>  <p>*Nut Driver + Drill offers fastest installation. If no Nut Driver is available, a socket wrench and socket may be used as a substitute.</p>	<p>Safety Glasses</p> 	<p>Tape Measure</p>  <p>Wrench</p>  <p>*Required only if nuts and bolts are used.</p>

Recommended tools to complete the installation:

<p>T-Square</p> 	<p>Pocket Level</p> 	<p>Towel</p> 	<p>Hammer and Punch</p> 	<p>Ladders*</p>  <p>*Tall ladder for installation on taller vehicles and containers. Small ladder for installation inside of containers or the exterior of smaller vehicles.</p>
<p>Torque Screwdriver/Adapter with Socket and Bits* (scale range of 0.4 N-m to 4.5 N-m, 4 in.-lb. to 40 in.-lb.)</p>  <p>*To check compliance with torque specifications for fasteners.</p>	<p>Water</p>  <p>*If cleaning is required.</p>	<p>File</p> 	<p>Cutting Lubricant* (Recommended)</p>  <p>*Recommended for faster drilling speed on thicker metals and longer drill bit life.</p>	

4.3 Matching a module identifier to an asset identifier

In order to track an asset, the Radar H2M IS module that is installed on the asset must be associated with the asset in the BlackBerry Radar Dashboard. It is, therefore, very important to keep a clear record of which Radar H2M IS module is installed on which asset.

The Dashboard application tracks modules and assets using ‘identifiers’. The asset identifier is the name or number of the asset you wish to track. The asset identifiers are entered into the application when you add the assets and will be listed on your installation worksheet. The identifier for each Radar H2M IS module is printed on two labels—one attached to the left end of the outer housing and the other on the bottom end of the outer housing. The module identifier also serves as the serial number (S/N) for the module.

To match a module identifier with an asset identifier:

1. Locate the module identifier for your device. The module identifier is shown in two places.
 1. Front of the outer housing
 2. Bottom end of the outer housing

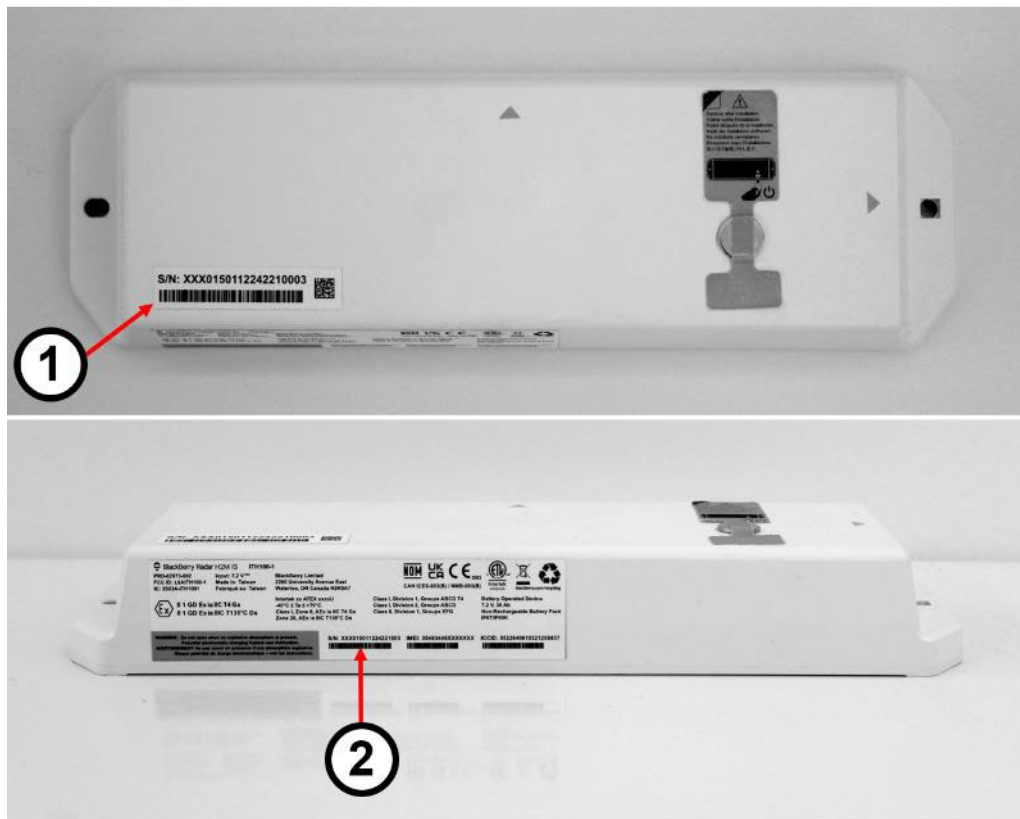

- Once you have installed the module on the asset, create a record of the module-to-asset-to-accessory pairing within the BlackBerry Radar Mobile App by recording the asset identifier and scanning the module identifier for the BlackBerry Radar H2M IS module and associated accessories.



- Tip:** If you are having difficulty scanning the barcode, please try the following:
- Place the phone in landscape orientation and retry scanning the barcode.
 - If barcode scanning is still unsuccessful, you may type the final five digits of the serial number into the Accessory ID field. Autocomplete will generate a list of serial numbers, from which, the installer may select the serial number that matches the module that is being installed.

- If you are unable to use the BlackBerry Radar Mobile App during your installation, you need to obtain a worksheet where you can record the pairing of each BlackBerry Radar H2M IS module to its asset and associated BlackBerry Radar accessories.

For your convenience, you may quickly create a record of the module and asset identifier pairings by removing the partially attached label from the outer housing of the module and placing it on the installation worksheet, next to the asset that will be tracked by the module.



Tip: For modules that have previously been transferred to new assets, the temporary S/N label may no longer be in place. If this is the case, you will need to write the module identifier (S/N) for each module on the installation worksheet.

Asset ID	Module ID Sticker	Accessory
ZG7419	WZ50000108311800001	

The following sections of this guide will illustrate recommended installation methods for various asset scenarios.

4.4 Module installation

WARNING: Do not attempt to install the device when an explosive atmosphere is present.

You may install the module on any flat, vertical or horizontal surface that offers enough mounting area for the module. When selecting a mounting location, carefully consider how the asset will be used during its normal, day-to-day operation.

Do not place the module in a location where it is susceptible to damage from:

- Normal usage activities, such as loading or unloading cargo or the asset.
- Moving parts of the asset.
- Road debris.

IMPORTANT: For accurate tracking, orientation matters.

1. Install the module vertically.

NOTE: For ease of install in the recommended locations, vertical orientation is preferred. Horizontal orientation may be used as an alternate orientation in areas where there is enough space to install the module horizontally.

2. When mounting on a vertical surface, always ensure the module is installed with the triangle for your desired orientation, pointing up. For easy recognition of the Intrinsic Safety (IS) information, we recommend an install placement where the IS label is easily visible for the operator.
3. Never install the module with the front of the module facing the ground.
4. **IMPORTANT:** To maintain the best GPS reception when the ISO tanks are stacked for storage or transport, we recommend installing the module on an inward-facing surface of the vertical support post. This installation location will reduce the chances of the GPS signal being blocked by another ISO tank container placed on the top of the ISO tank container that is being monitored and protect the module from damage.

This diagram illustrates the supported installation orientations for the BlackBerry Radar H2M IS module.

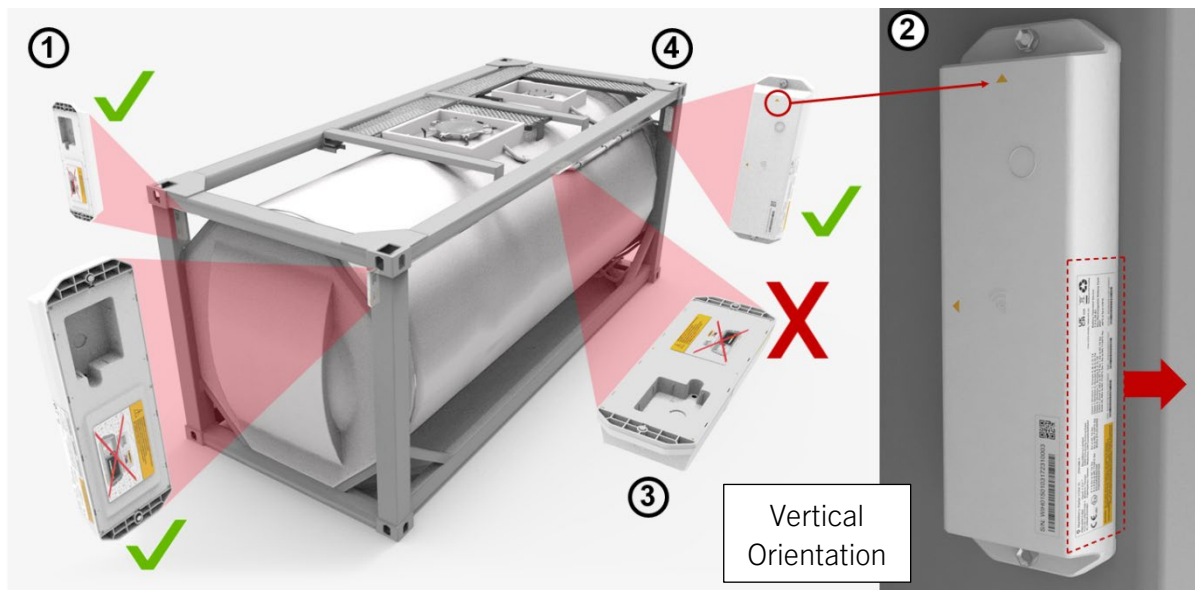

4.4.1 ISO tank container installation procedure

To track your ISO tank's location with the BlackBerry Radar H2M IS module, the recommended module placement is as follows:

- The module should be placed as high on the asset as possible for optimum antenna performance. The exact placement height will be influenced, in part, by various factors including: the height of the ladder used for the install, construction of the ISO tank, etc.

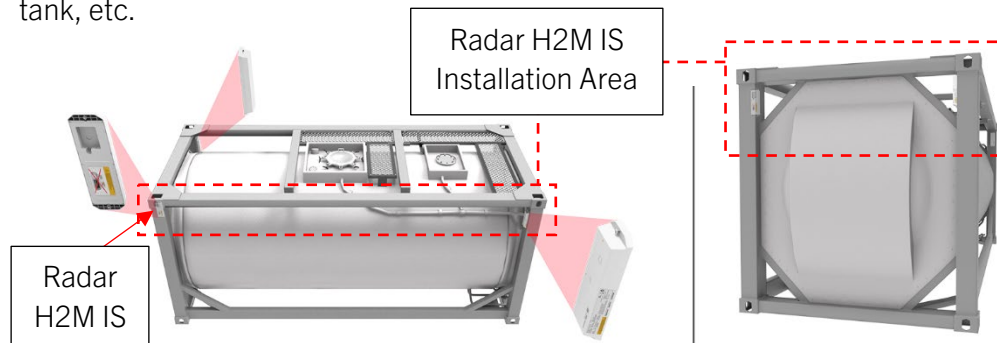

- To maintain the best GPS reception when the ISO tanks are stacked for storage or transport, we recommend installing the device on an inward-facing surface of the vertical support post.
 - Installation on the vertical post will reduce the chances of the GPS signal being blocked by another ISO tank container placed on the top of the ISO tank container that is being monitored.
 - Installation on the inward-facing surface of the vertical support post will protect the module from being damaged when the ISO tank is placed directly next to other ISO tanks during storage or transport.

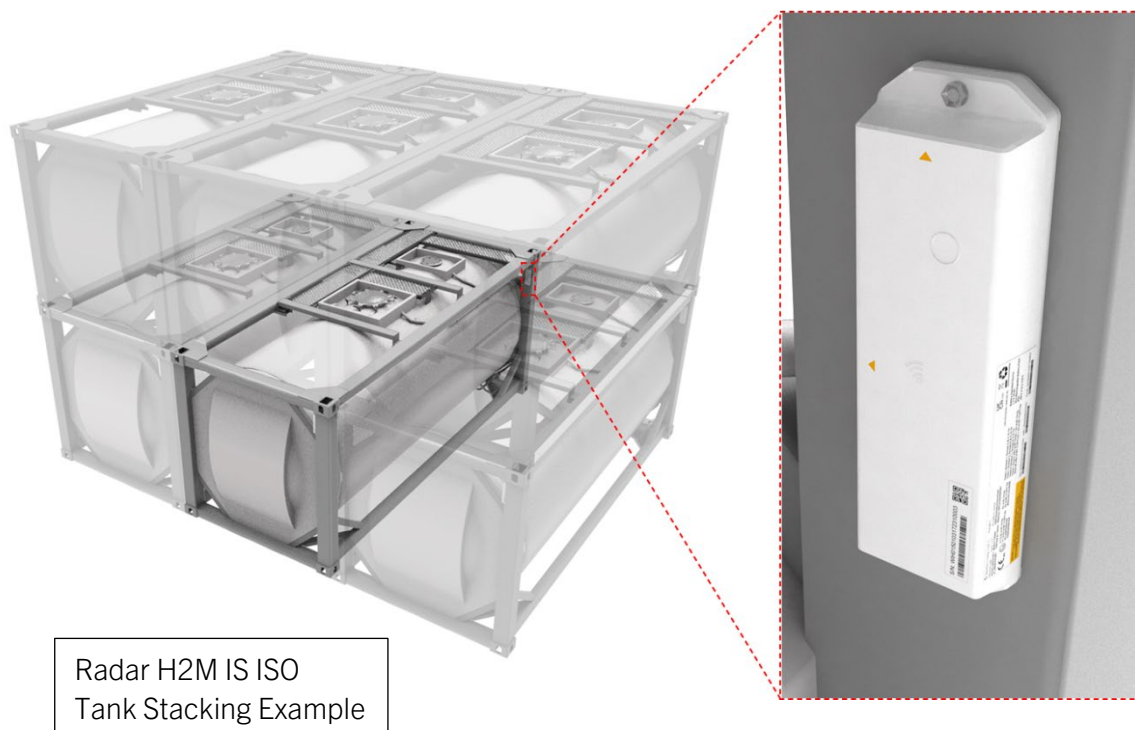

**Scenario 1:
Vertical Orientation**

Follow these instructions if you plan to install to the vertical posts of the ISO tank, in the vertical orientation.

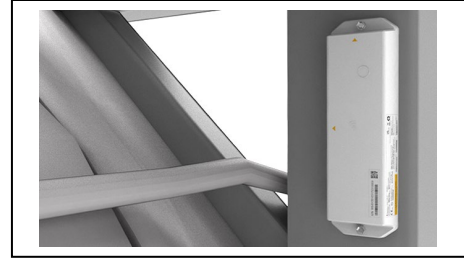

SPECIAL NOTE: To preserve the Intrinsic Safety of the BlackBerry Radar H2M IS module, if the module is dropped at any point during the handling or installation process, please replace with a different module that has not been dropped.

1. Remove the module and Installation Template from the packaging.



2. After selecting the best installation location for your container, remove the liner from the rear of the template and place the template in the desired installation location. The adhesive at the back of the template ensures that it stays on the door surface for accurate drilling of your holes.

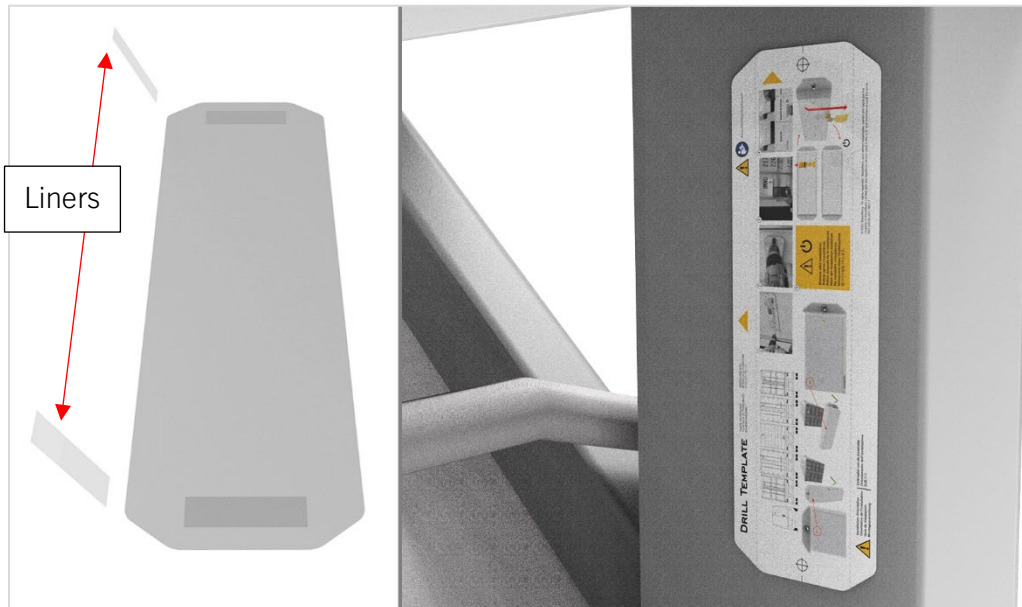

It is recommended that you install the module as level as possible on the asset. To help ensure the module is level, you may try one of the following techniques.

Technique 1: Position the square along the vertical edge of the installation surface. Using the square as a guide, align the bottom edge of the template to the square.

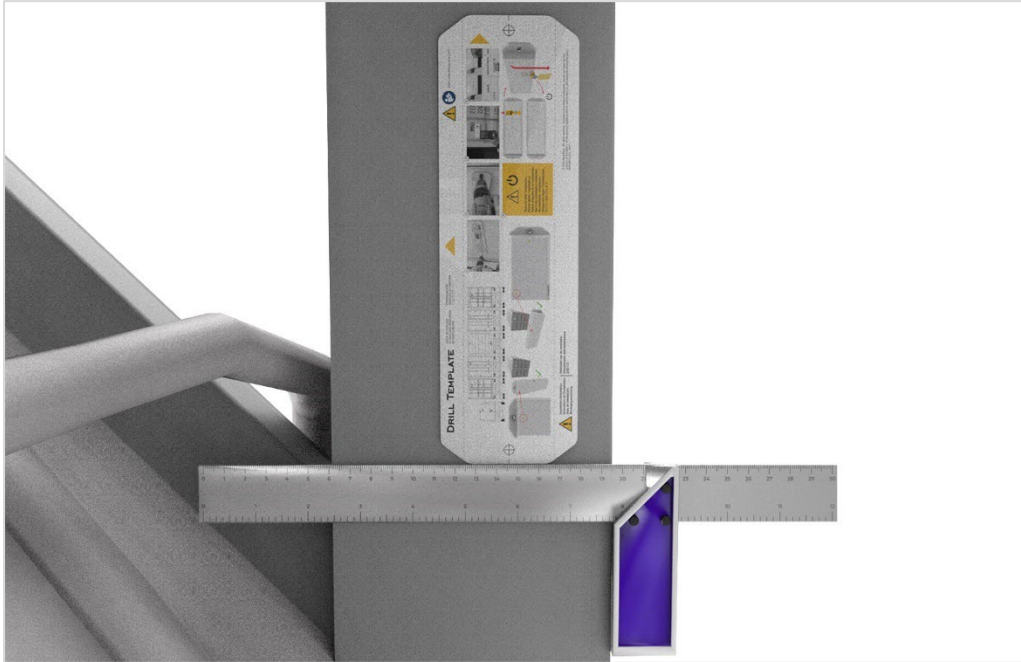

Technique 2: Visually, place the template in the desired installation location. Using a level, check that the template is level.

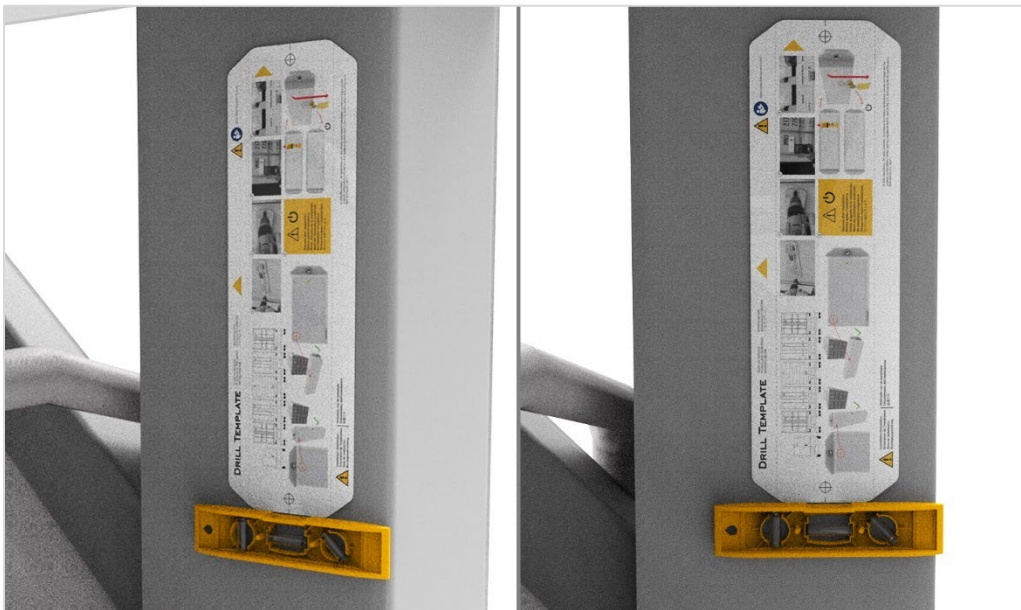

- Using a drill bit, drill a hole through each of the cross hairs on the template. This will create two holes you will use to mount the module.



Drilling tips for intermodal installations

Due to the thicker, harder steel used on ISO tank containers, you may wish to follow these suggestions.

Tip 1: To shorten drilling time and prolong the life of your drill bit, you may wish to use cutting tool lubricant during the drilling process.

Tip 2: To achieve precise hole drilling, before drilling your hole, you may wish to use a punch and hammer to help place the drill bit. This will prevent the bit from “walking” during the drilling operation.

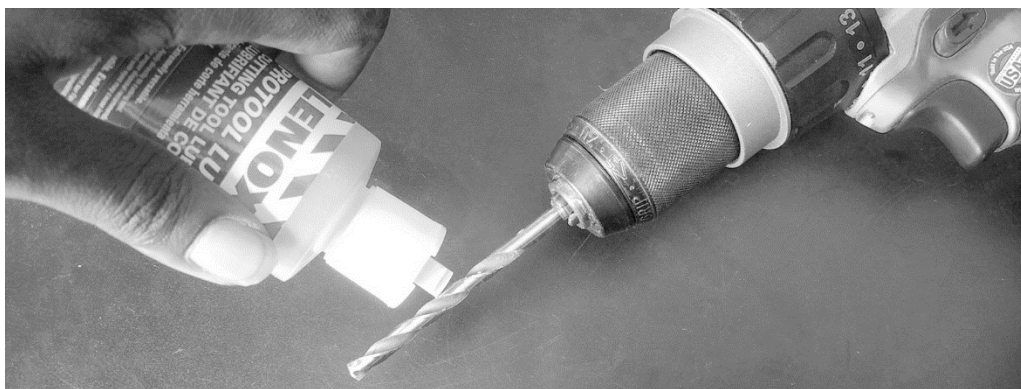

4. Remove the template. You now have two holes in the post. If there are any burrs around the holes, remove them at this time. Also, remove any dust or debris left over from the drilling or de-burring operations and ensure surface is clean and dry.

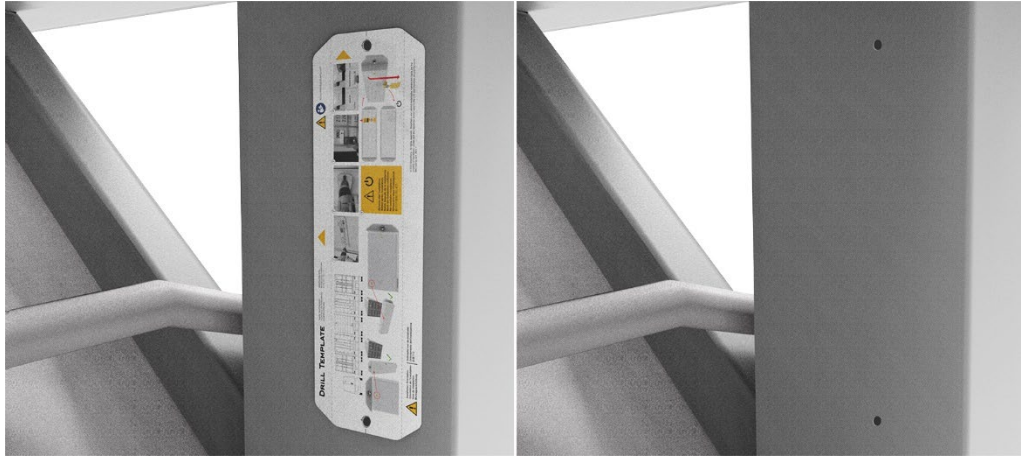

5. Ensure the arrow on the top of the housing is pointing to the sky. Place the module on the door, aligning the holes on the module with the holes you drilled into the door.

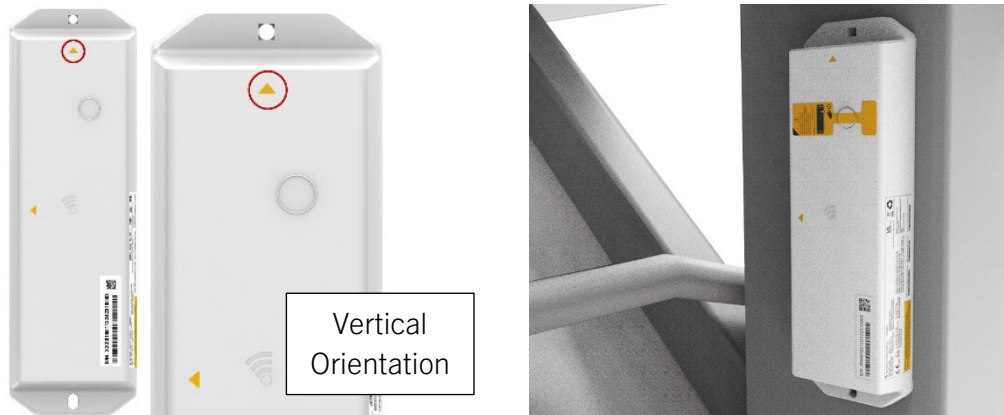

6. Insert your fastener of choice into the holes and use the appropriate tools to secure the module to the asset.



Do not over-tighten the fastener. Do not tighten fastener beyond 35 in-lb. (4N-m).

- Once you have installed the module on the asset, create a record of the module-to-asset-to-accessory pairing within the BlackBerry Radar Mobile App by recording the asset identifier and scanning the module identifier for the BlackBerry Radar H2M IS module and associated accessories with the smartphone. Remove the small temporary S/N label from the module.



- Tip:** If you are having difficulty scanning the barcode, please try the following:
- Place the phone in landscape orientation and retry scanning the barcode.
 - If barcode scanning is still unsuccessful, you may type the final five digits of the serial number into the Accessory ID field. Autocomplete will generate a list of serial numbers, from which, the installer may select the serial number that matches the module that is being installed.

If you are unable to use the BlackBerry Radar Mobile App during your installation, you need to obtain a worksheet where you can record the pairing of each BlackBerry Radar H2M IS module to its asset and associated BlackBerry Radar accessories.

For your convenience, you may quickly create a record of the module and asset identifier pairings by removing the partially attached label from the outer housing of the module and placing it on the installation worksheet, next to the asset that will be tracked by the module.

BlackBerry Radar
Date: March 26, 2023
Installer: sbs.install@blackberry.com

Asset ID	Module ID Sticker	Accessory ID Sticker	Usage (Optional)
IMNU217362			
IMNU216532			
IMNU215743			
IMNU216147			
IMNU216548			
IMNU215443			

Asset ID

IMNU217362

Module ID Sticker

S/N: XXX0150112242210003

Acce

7. Activate your modules, using the following process.
 - A. On the module, locate a corner of the magnet tape and lift.



- B. Continue to lift the magnet tape and fully remove the magnet tape from the module. Lifting the magnet tape will remove the magnet from the magnet ring.

IMPORTANT: The magnet functions as the “Power” switch for the module. The magnet must be completely removed from the module for the module to operate.

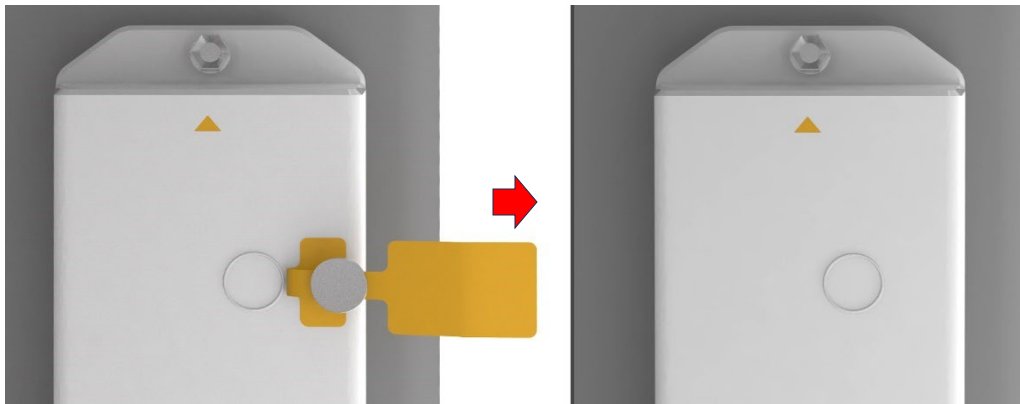

IMPORTANT NOTES ON MAGNET USE

Save and Reuse your Magnets: Once the magnet is removed from the module, we recommend saving some magnets, at your service facility. Maintaining an adequate supply of these magnets can assist in the long-term operation of your device, as the magnets will be required to facilitate module resets or to shut down the device for shipping previously active Radar H2M IS modules between locations.

For a full explanation of the module reset procedure, please refer to **Section 4.4.2: Power Cycling your BlackBerry Radar H2M IS modules**. For a full explanation of the module Shipping Procedure, please refer to **Section 6.4: Preparing your BlackBerry Radar H2M IS modules for Shipping**.

8. Installation is complete.



4.4.2 Power Cycling BlackBerry Radar H2M IS modules

Use this procedure if you need to “power-cycle” your BlackBerry Radar H2M IS module.

IMPORTANT: This procedure only works on modules where the Magnet Power Control feature has been disabled in the BlackBerry Radar Dashboard.
Before attempting to power cycle your module, please consult the BlackBerry Radar Dashboard to ensure the Magnet Power Control feature is disabled for the modules you are attempting to power cycle.

1. Locate one of the magnets you removed during the installation/activation of the BlackBerry Radar H2M IS module.



2. Place the magnet within the magnet ring on the front of the housing. Hold the magnet within the magnet ring for at least 5 seconds, then remove the magnet from the module. The module will reboot and reconnect to the cellular network within 5 minutes.

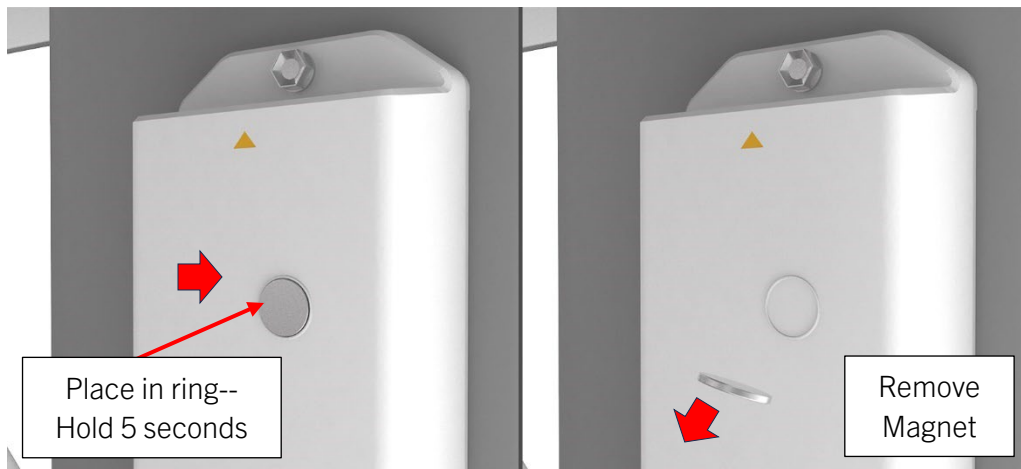

5 Cleaning BlackBerry Radar H2M IS modules

WARNING: Exposure to some solvents may degrade the sealing properties of materials used in the device. Avoid exposing your device to these solvents.

1. For best performance, regularly clean the housing on every service interval of your asset. The cleaning of this module can be performed inside and outside of a Hazardous area using a cloth, dampened with water, to avoid any Electrostatic Discharge risk.



6 Removing BlackBerry Radar H2M IS modules

Use this procedure if you need to remove your BlackBerry Radar H2M IS module from your asset.

For more information on obtaining service for your devices, or recycling and safe disposal of your devices and batteries, contact your BlackBerry representative, or visit the following:





blackberry.com/RadarSupport--for information on service and the recycling and safe disposal of your device and battery.

Note: If you plan to ship your Radar H2M IS module, please be aware that the module, is considered Fully Regulated Class 9 Dangerous Goods in all modes of transportation (Air, Ocean, and Ground) and must only be shipped in special UN certified Dangerous Goods packaging. If you are returning the module to BlackBerry, you may request this UN-certified packaging from BlackBerry.

Also, any person who handles, offers for transport, or transports Dangerous Goods must be adequately trained and hold a training certificate; or perform those activities in the presence and under the direct supervision of a person who is adequately trained and who holds a training certificate.

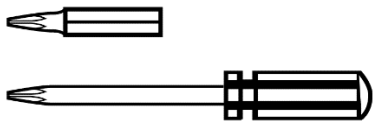
Products that are considered Dangerous Goods can only move on carrier accounts that are approved for Dangerous Goods and are subject to Dangerous Goods surcharges. The Radar H2M IS module, when shipped without the battery, are not subject to these surcharges.

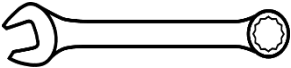
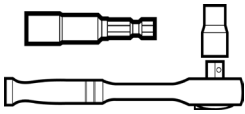
6.1 Removal tools

<p>Screwdriver or Bit</p> 	<p>Drill</p> 	<p>Wrench</p>  <p>*Required only if nuts and bolts are used.</p>
<p>Nut Driver or Socket Wrench with Socket*</p>  <p>*Nut Driver + Drill offers fastest removal. If Nut Driver is unavailable, a socket wrench and socket may be used.</p>	<p>Safety Glasses</p> 	<p>Caulking Gun and Polyurethane Sealant</p>  <p>*Recommended for sealing holes.</p>

6.2 Module removal

1. Remove the module from the asset by removing the two fasteners from the ends of the module and remove the module.

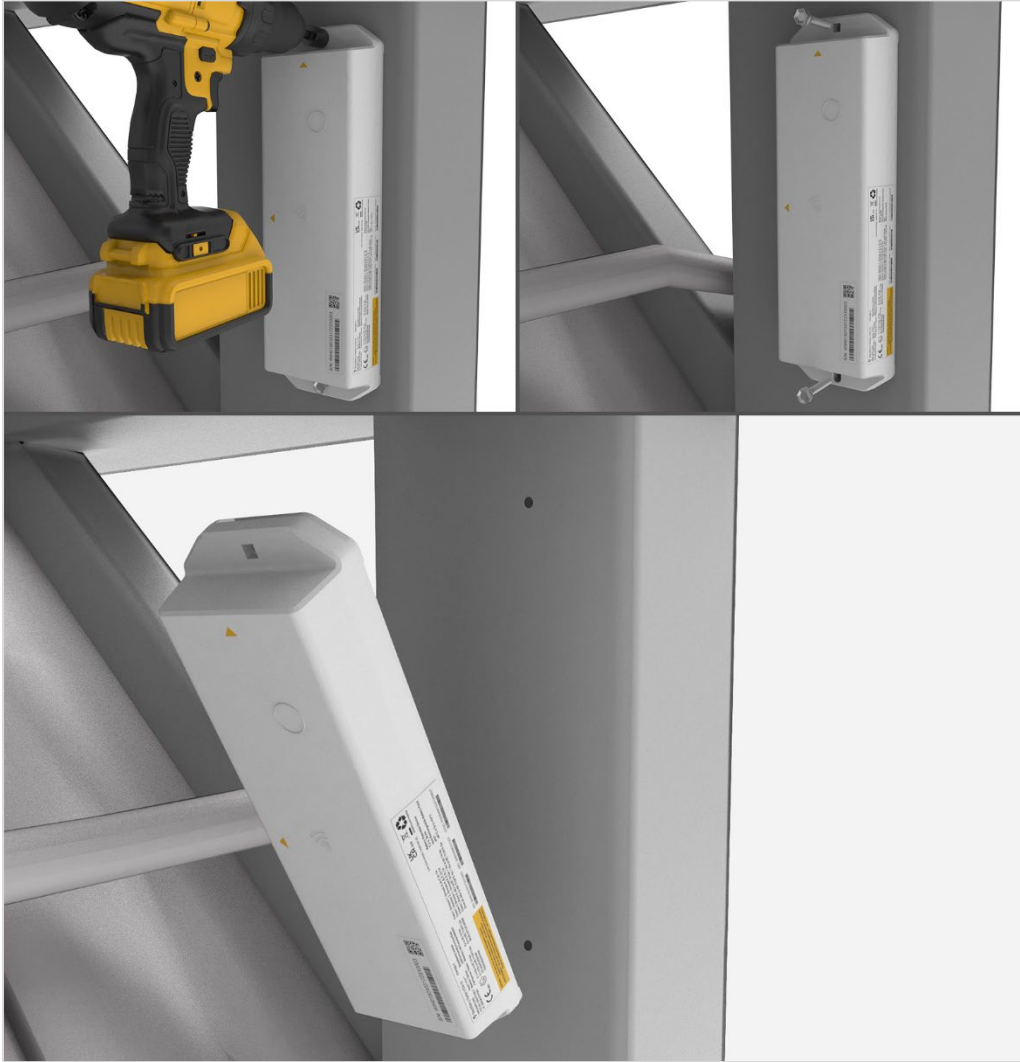

6.3 Battery removal and replacement

**WARNING: Do not open the device when an explosive atmosphere is present.
Do not attempt to replace the battery when an explosive atmosphere is present.**

Work environment

1. When replacing your battery, we recommend performing the replacement in an indoor environment, free from dust, water, and other airborne contaminants. We also recommend performing the battery replacement on a flat work surface and the use of a small container to temporarily hold the screws during the battery removal/replacement operation.

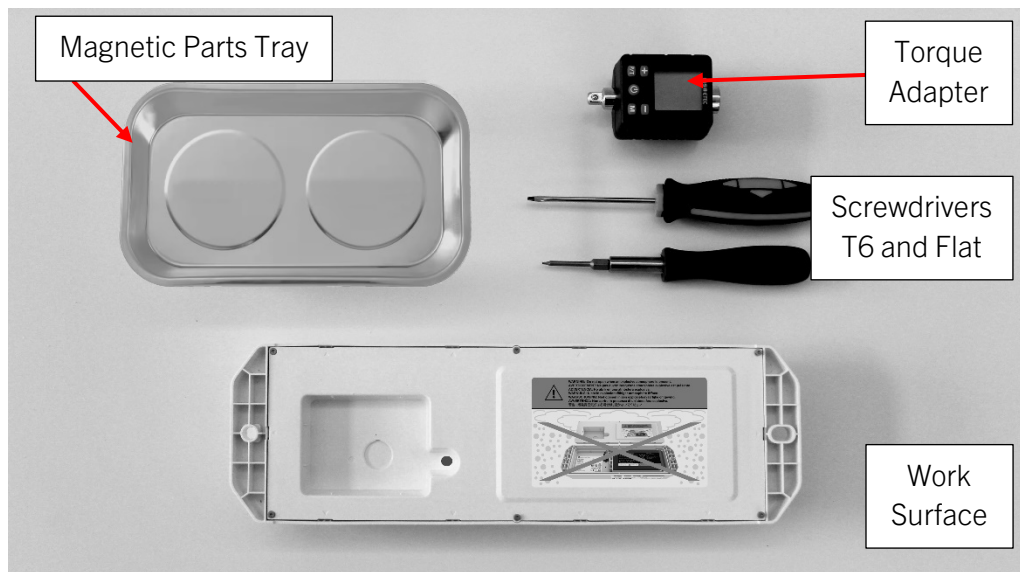

Battery removal

1. Using a T6 Torx screwdriver, remove the six screws from the back of the product to access the battery. Retain the screws as all six screws will be required to re-secure the battery door to the outer housing.

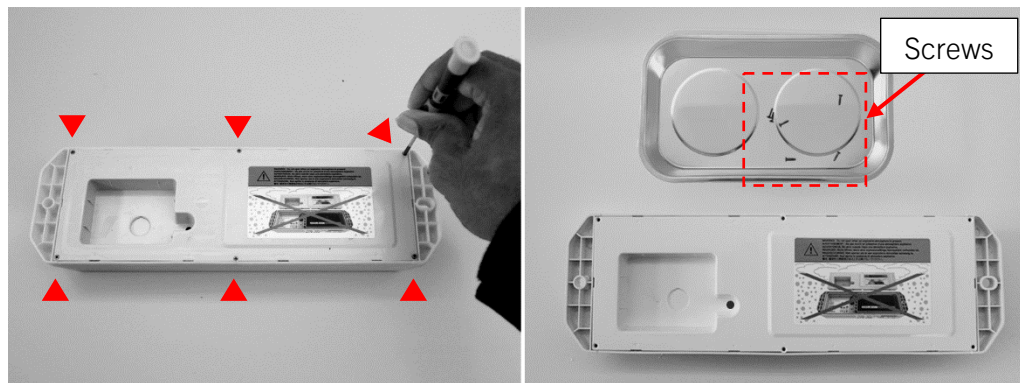

Tip: The use of a Magnetic Parts Tray is recommended to collect the screws.

2. To separate the battery door from the outer housing—begin by inserting a flat screwdriver (3-7mm width) into the far-left or far-right slot, marked with the arrows, and pry upwards. Complete the battery door removal by working your way around the door--inserting the screwdriver into the other slots and prying upwards, until the door is free.

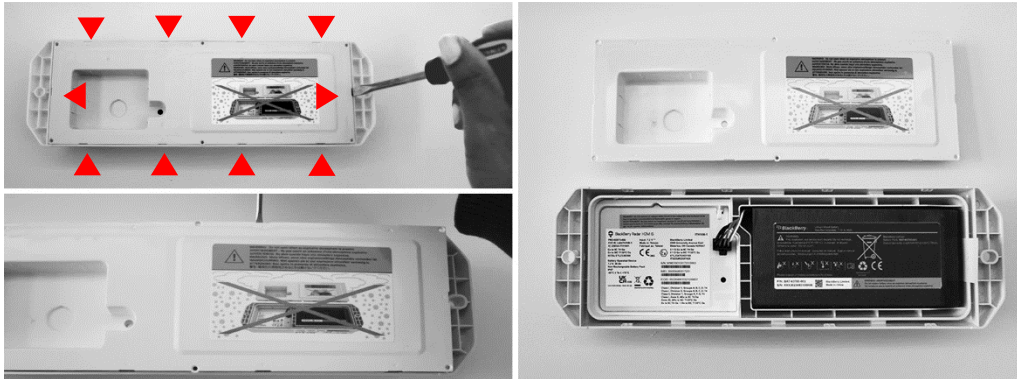

3. Disconnect the battery cable from the battery connector.

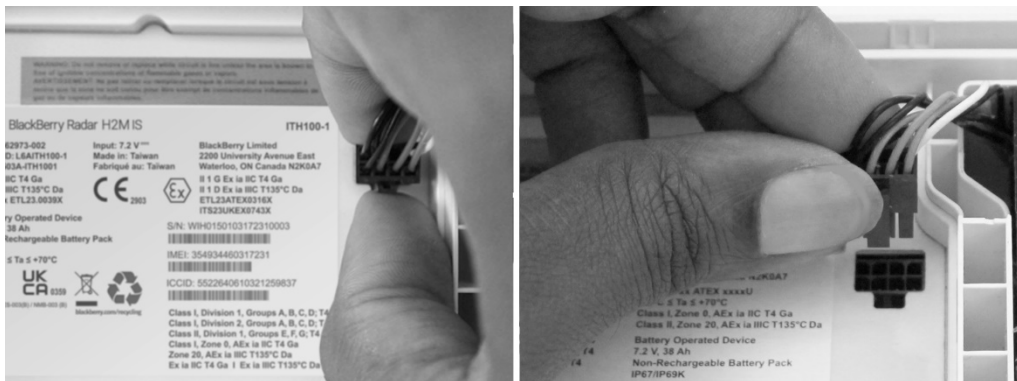

4. Remove the battery from the battery compartment by grasping the pull tab and lifting the battery out of the compartment.



Battery replacement

WARNING: Use only replaceable battery packs Blackberry BAT-63705-003 or BAT-63705-004.

1. Insert the replacement battery into the battery compartment.

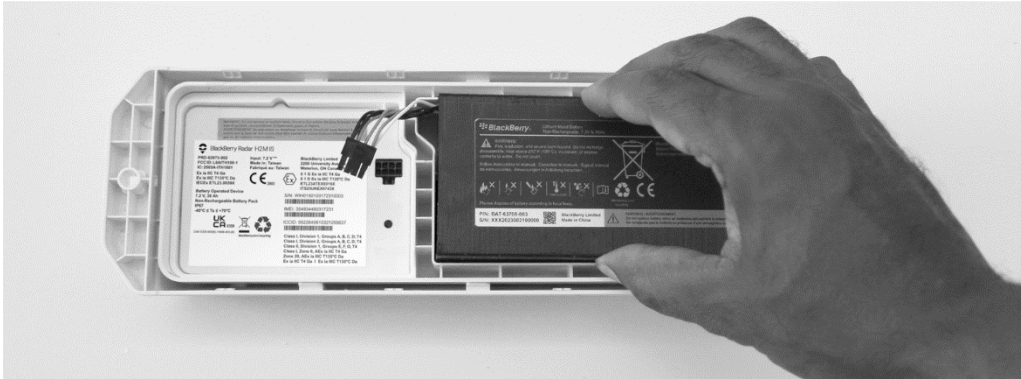

2. Connect the battery cable to the battery connector. The LED will blink to indicate the module is active. NOTE: It can take between 20-30 seconds for the blink sequence to begin. Please be patient. Once you see the LED blink, continue to the next step.

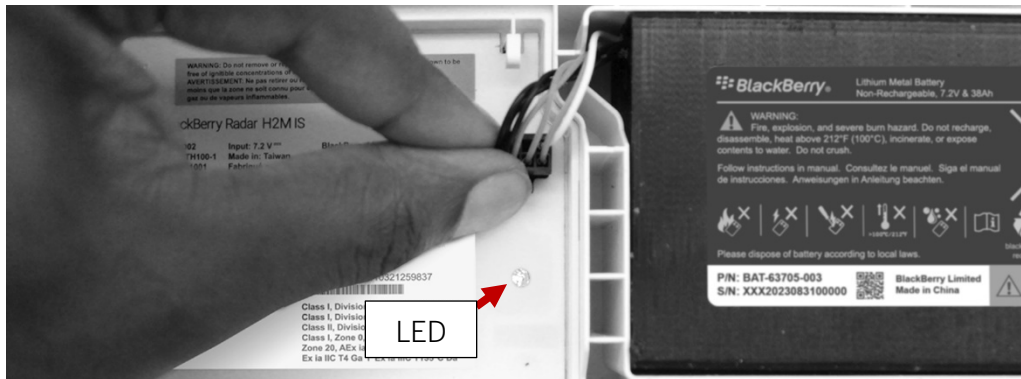

3. Fully install the battery door.



IMPORTANT: Ensure the battery door is fully seated onto the housing by firmly pressing the door at the door's corners and at each arrow embossed into the door.



4. Using a Torx T6 screwdriver, install the screws to secure the battery door.

IMPORTANT: Screw torque must be 2.6 in-lb (0.3 N-m).

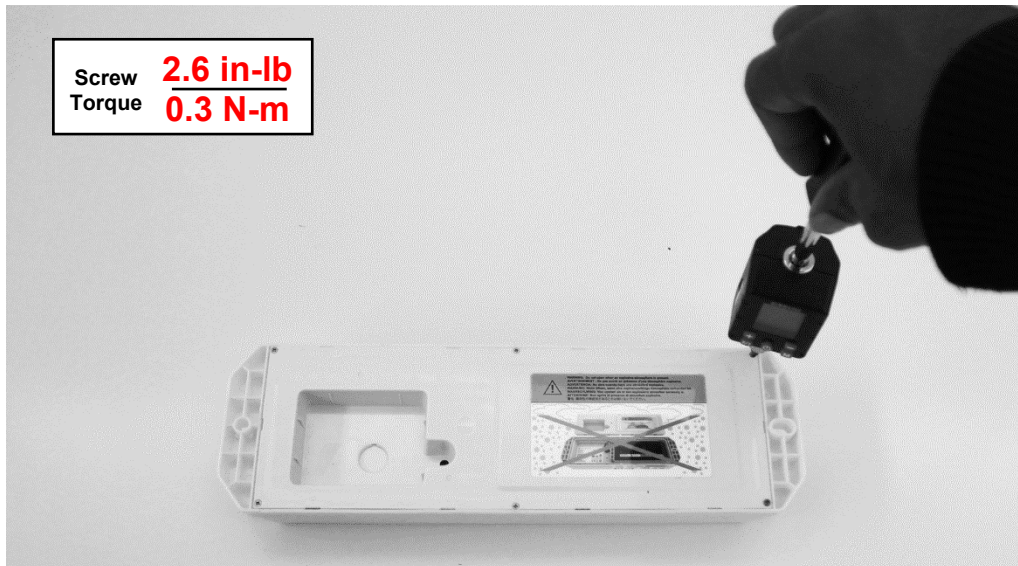

6.4 Shipment prep

If you ever need to ship your BlackBerry Radar H2M IS module, there are different procedures to use. Which procedure to use, varies, based on whether you are shipping with a battery installed in the module, or not. The following is a summary of the scenarios we will cover in this Installation Guide.

Scenario 1: Shipping BlackBerry Radar H2M IS, with the battery installed and connected.

Scenario 2: Shipping BlackBerry Radar H2M IS, with the battery installed and disconnected.

Scenario 3: Shipping BlackBerry Radar H2M IS, without the battery.

Scenario 1: Shipping BlackBerry Radar H2M IS, with the battery installed and connected

If shipping BlackBerry Radar H2M with the battery installed and connected, please follow this procedure.

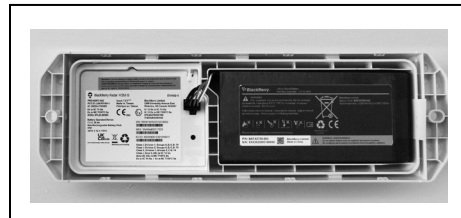

IMPORTANT: To transport or ship your module with the battery installed and connected, the module must be powered off. By default, the magnet functions as the “Power” switch for the module.

The magnet’s ability to control the power may be disabled by enabling the Magnet Power Control feature in the BlackBerry Radar Dashboard. To ensure the magnet will power off the module—the Magnet Power Control feature must be disabled.

Before attempting to transport, or ship, your modules--please consult the BlackBerry Radar Dashboard to ensure the Magnet Power Control feature is disabled on the modules you are attempting to ship.

1. Locate the magnet that shipped with your device, and place within the magnet ring on the front of your product.

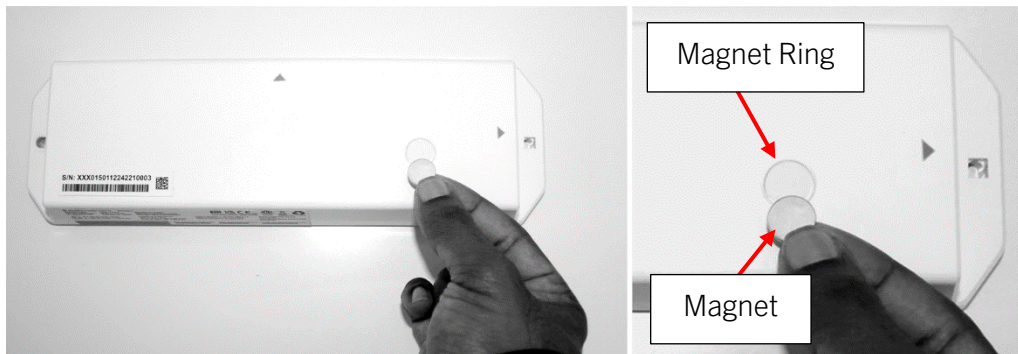

2. Apply a piece of strong tape to keep the magnet in place during transit. If you plan to do any shipping of your device, you may request a sheet of Magnet Tape from your BlackBerry representative.

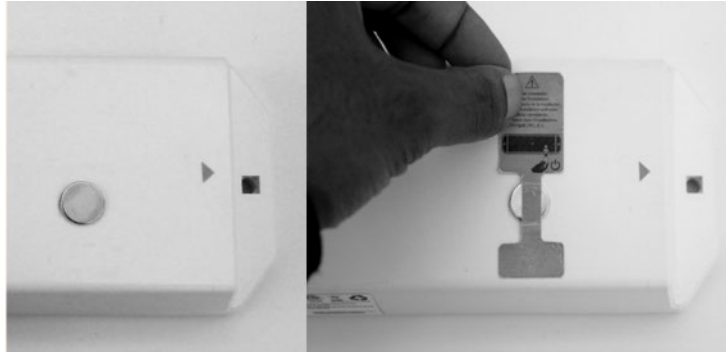
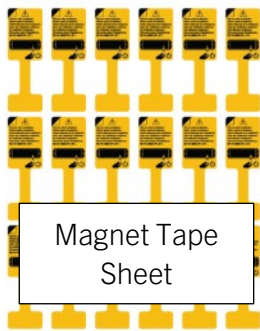

IMPORTANT: When the battery is connected, never ship the module without the magnet in place. The magnet is necessary to keep the module powered off during transit.

3. Module is now ready for placement into the UN certified Dangerous Goods packaging.



**Scenario 2:
 Shipping BlackBerry Radar H2M IS, with the battery
 installed and disconnected.**

If you don't have a power on/off magnet, but need to send the module, along with the battery, follow this procedure.

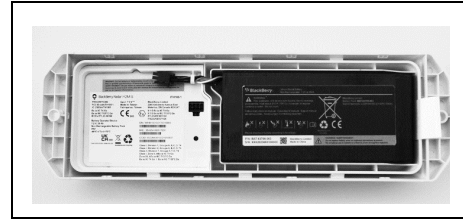

IMPORTANT: To transport, or ship your module with the battery, the module must be powered off. If the battery is disconnected, there is no power to the device and the device is powered off.

Before attempting to transport, or ship, your modules according to this method—you must ensure the battery is disconnected, and the cable stowed as illustrated in these instructions.

1. Using a T6 Torx screwdriver, remove the six screws from the back of the product to access the battery. Retain the screws as all screws will be required to re-secure the inner housing to the outer housing.



2. To separate the battery door from the outer housing—begin by inserting a flat screwdriver (3-7mm width) into the far-left or far-right slot, marked with the arrows, and pry upwards. Complete the battery door removal by working your way around the door--inserting the screwdriver into the other slots and prying upwards, until the door is free.

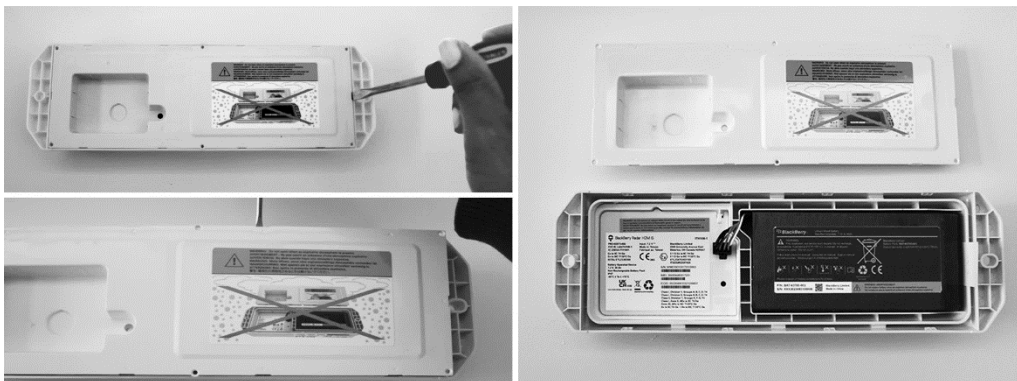

3. Disconnect the battery cable from the battery connector.

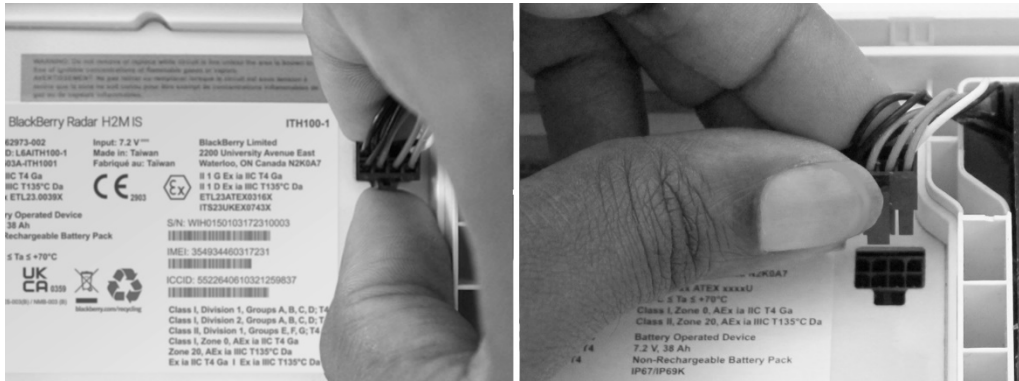

4. Store the battery cable by placing the battery cable under the battery connector retainer. **NOTE:** Battery cable must be stowed for transit to prevent unintended contact with the battery terminals.

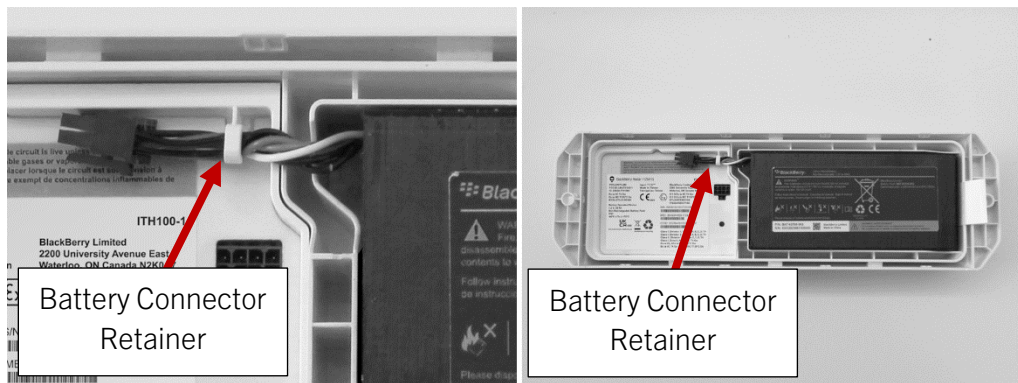

5. Place the battery cover onto the module. Place the screws in the circular recess on the battery door and cover with tape. Leaving the screws uninstalled is recommended as an indicator to the recipient that the battery is disconnected and must be connected before its next use. Module is now ready for placement into the UN certified Dangerous Goods packaging.



Scenario 3:
Shipping BlackBerry Radar H2M IS, without the battery.

If you only need to send the device and do not need to send the battery, follow this procedure.

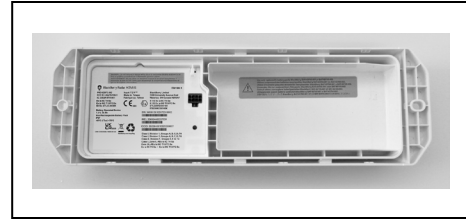

IMPORTANT: To transport, or ship your module without the battery, the module must be powered off. If the battery is disconnected, there is no power to the device and the device is powered off.

Before attempting to transport, or ship, your modules according to this method—you must ensure the battery is disconnected, and the cable stowed as illustrated in these instructions.

1. Using a T6 Torx screwdriver, remove the six screws from the back of the product to access the battery. Retain the screws as all screws will be required to re-secure the inner housing to the outer housing.



2. To separate the battery door from the outer housing—begin by inserting a flat screwdriver (3-7mm width) into the far-left or far-right slot, marked with the arrows, and pry upwards. Complete the battery door removal by working your way around the door--inserting the screwdriver into the other slots and prying upwards, until the door is free.

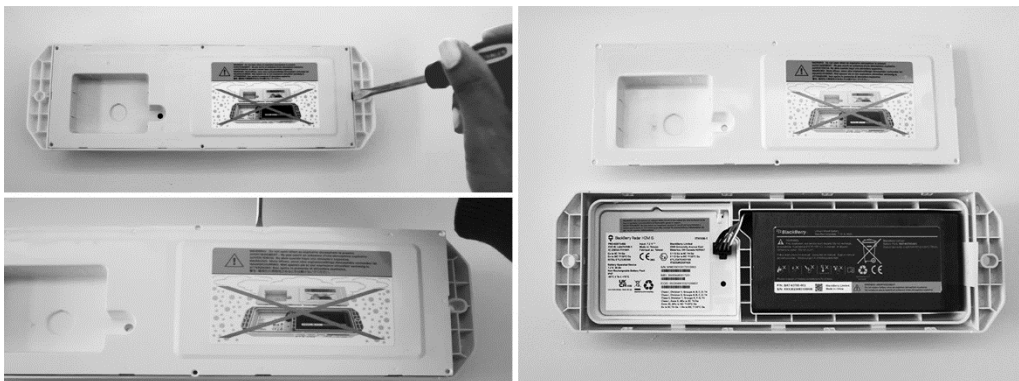

3. Disconnect the battery cable from the battery connector.

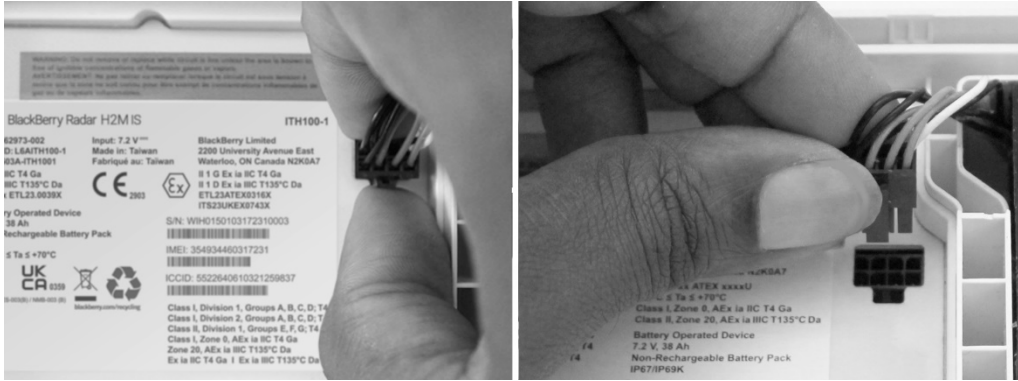

4. Remove the battery from the battery compartment by grasping the pull tab and lifting the battery out of the compartment.



5. Place the battery cover onto the module. Place the screws in the circular recess on the battery door and cover with tape. Leaving the screws uninstalled is recommended as an indicator to the recipient that there is no battery installed and must be installed before its next use. Module is now ready for placement into the UN certified Dangerous Goods packaging.



7 Support

If you run into any problem during the installation process, contact the BlackBerry Radar support team at 1-844-RADAR-BB.

Legal notice

©2025 BlackBerry. All rights reserved. BlackBerry® and related trademarks, names, and logos are the property of BlackBerry Limited and are registered and/or used in the U.S. and countries around the world. All other trademarks are the property of their respective owners. This documentation, including any references to third-party sources of information, hardware or software, products or services (“Third Party Products and Service”), is provided or made accessible "AS IS" and "AS AVAILABLE" and without condition, endorsement, guarantee, representation, or warranty of any kind by BlackBerry Limited and its affiliated companies ("BlackBerry"). BlackBerry assumes no responsibility for any typographical, technical, or other inaccuracies, errors, or omissions in this documentation and reserves the right to periodically change information that is contained in this documentation. The terms of use of this documentation and any BlackBerry product or service are set out in a separate license or other agreement with BlackBerry applicable thereto. Certain features outlined in this documentation may require Third Party Products and Services and your use of Third Party Products and Services shall be governed by and subject to you agreeing to the terms of separate agreements applicable thereto with third parties.

BlackBerry Limited
2200 University Avenue East
Waterloo, Ontario
Canada N2K 0A7

Published in Canada